

N91-22141

**INDUSTRIALIZING THE NEAR-EARTH ASTEROIDS:
Speculations on Human Activities in Space in the
Latter Half of the 21st-Century**

by Joel C. Sercel
Jet Propulsion Laboratory
California Institute of Technology

Presented at the Vision 21 Symposium
April 3-4, 1990
NASA Lewis Research Center, Cleveland, Ohio

ABSTRACT

The use of solar system resources for human industry can be viewed as a natural extension of the continual growth of our species' habitat. Motivations for human activities in space can be discussed in terms of five distinct areas: i) information processing and collection, ii) materials processing, iii) energy production to meet terrestrial power needs, iv) the use of extraterrestrial materials, and v) disaster avoidance. When considering 21st-century activities in space, each of these basic motivations must be treated in the light of issues likely to be relevant to the 21st-century Earth. Many of the problems facing 21st-century Earth may stem from the need to maintain the world population of 8 to 10 billion people as is projected from expected growth rates. These problems are likely to include managing the impact of industrial processes on the terrestrial biosphere while providing adequate energy production and material goods for the growing population.

The most important human activities in space in the latter half of the 21st-century may be associated with harnessing the resources of the near-Earth asteroids for industrial processes. The near-Earth asteroids are estimated to contain approximately 10^{17} kg of material, enough to have a profound effect on terrestrial industrial processes. However, if this material is to be of use, challenges associated with the high cost of access to space, the hazards of the space environment, as well as other difficulties associated with any new enterprise, such as obtaining required capital investments, legal issues, and national policy issues must be overcome. The functions a space industry must accomplish include raw material collection, processing raw materials into useful feedstocks, parts fabrication, product assembly, and transport of products to Earth. Dramatic advancements in the technologies of power systems, sensors, and command and control systems will obviously be needed.

If the needed technological advancements are made, an important option to consider for harnessing space resources is that of replicating manufacturing systems. A key aspect of these systems is closure. Three types of closure have been identified as important: energy closure, information closure, and matter closure. If perfect closure in each of these areas could be achieved, the result would be a von Neumann* machine. Although the prospects of producing a true von Neumann machine are not good, replicating systems with imperfect closure can be made to effectively support space industrialization. The benefit of the exponential growth of replicating systems can be significant. Calculations suggest that within a few decades of the initial deployment of a replicating space factory, the total capacity of a space industry could exceed that of the Earth. Initially, products manufactured in space will be used in space, but eventually it will be cost effective to import goods to the Earth. Given the magnitude of the potential benefit of such a full-scale space industry, development of advanced automation technology and extraterrestrial materials processing systems should be vigorously pursued.

* The term *von Neumann machine* is used to describe a class of self-replicating automata which exhibit complete closure. John von Neumann is generally credited with having conducted the first rigorous mathematical treatment of self-replicating machines in the 1950s.

THE HUMAN DIASPORA AND MOTIVATIONS FOR ACTIVITIES IN SPACE

The stated purpose of the of the Vision 21 Symposium is to foster innovative thinking about space activities for the next millennium. To this end, I will talk about possibilities that will come after the Space Exploration Initiative, which NASA is now studying as the focus of our space program for the first few decades of the 21st-century. I will address space activities in which our species makes the transition from exploration to industrialization of the solar system. In particular, I will focus on how people of the 21st-century may use the near-Earth asteroids.

Before beginning this discussion of solar system industrialization, it will be useful to first describe what I refer to as the "Human Diaspora." The term is used here to refer to the process whereby human beings extend their habitat from some limited region into another, larger region. The Human Diaspora extends along a continuum in which one can identify four stages. The first stage is Exploring, whereby human beings identify and visit new habitats. The second stage is Prospecting, in which we survey new habitats for sources of wealth or other benefits. After the Prospecting stage comes Pioneering, during which initial attempts to harvest benefits from the new habitats are made. The final stage of the Human Diaspora is Settling and/or Industrializing, in which the potential benefits of new habitats are fully exploited. The word *diaspora* has the same root origins as the word *dispersion*, but it can mean a dispersion of any originally homogeneous people. To my knowledge the first person to apply the term diaspora to the human settlement of space was Robert Heinlein in his now classic-science fiction stories about the exploits of Lazarus Long.¹

The Human Diaspora has been an on-going process which started prehistorically and continues today as human beings move into ever expanding habitats. In recent history, however, one observes an interesting new feature of the process: With technology, human beings are no longer required to physically travel into new habitats to accomplish the four stages of the Human Diaspora. For example, robotic spacecraft sent to the outer solar system are presently engaging in completely robotic exploration. I suggest that this new trend - in which we let our technology do the traveling for us - is an important new wrinkle, and one we should consider carefully in planning future human activities in space.

The concept of the Human Diaspora is presented here to provide a backdrop against which we can discuss human development of the solar system. Also useful is a classification of the basic motivations for human activities in space. For the purpose of this paper, I have classified five basic motivations: Information Processing and Collection, Materials Processing, Energy Production, Use of Extraterrestrial Materials, and Disaster Avoidance. Table 1 gives examples of space projects - either proposed, in progress, or completed - associated with each of these motivations.

Table 1 - Motivations for Human Activities in Space
and The Stage of Each in the Human Diaspora

| MOTIVATION | EXAMPLES | PRESENT STAGE |
|---|--|---------------------------------|
| Information Processing and Collection | Communications, Science, and Earth Observations | Settling and Industrializing |
| Material Processing | Pharmaceuticals and Electronics | Pioneering |
| Energy Production for Terrestrial Use | Solar Power Satellites, Space Disposal of Nuclear Waste, Lunar He ³ | Prospecting |
| Use of Extraterrestrial Materials | Mining Common Materials and Rare Metals, Manufacturing Goods | Prospecting |
| Disaster Avoidance | Asteroid Deflection, Weather Modification, Climate Control | Exploring and Prospecting |

Table 1, under the motivation "Information Processing," lists communications, Earth observations, and science. In these areas, we are presently well into the industrialization stage. Under "Materials Processing" are included the experiments that are frequently conducted on the space shuttle or on the Soviet Mir space station. In these experiments, the unique features of the orbital environment are used to develop new pharmaceuticals and semiconductors. While the products of these experiments are valuable, it is likely that much more benefit is yet to be realized in the area of space-materials processing. As such, the level of development associated with present work in space materials processing is still in what I refer to as the Prospecting stage of the Human Diaspora.

Activities which fall under the motivation "Energy Production" for net energy benefit here on the Earth are still in the early Exploration stage. An example of the exploratory thinking that has been done in space energy production is the work of Peter Glaser who first proposed and then studied the concept of the space solar-power satellite in the 1960s and the 1970s.² Gerard O'Neill, who proposed the human colonization of space habitats, suggested space solar-power satellites as a justification for human colonies in space, with the space colonists working to manufacture power satellites.³

Another concept that may be worth considering more seriously in the near future is that of space disposal of nuclear waste.⁴ If nuclear power continues to be used on the Earth, safe places to store nuclear waste products will continue to be required. Many argue that the surface of the Earth is not a good place for such storage. If we can develop a

sufficiently reliable space launch system and find ways to ensure that nuclear waste can be safely launched into space, the possibility of nuclear waste disposal in space will have merit.

Mining lunar He^3 is an idea first proposed by a group from the University of Wisconsin. Mining lunar He^3 may be of interest in the 21st-century because He^3 produces less neutron radiation (when reacted with deuterium) than other proposed fuels for nuclear fusion. The problem with He^3 is that it is very difficult to obtain on the surface of the Earth. The Moon, however, possesses an abundant source of He^3 , which is there because solar wind continually deposits it into the top layers of lunar regolith. The University of Wisconsin group and others have suggested there may be benefits associated with extracting He^3 from lunar regolith for transport to Earth, where it may be useful for electric power production.

Space activities motivated by "Use of Extraterrestrial Materials," include mining of common materials from extraterrestrial sources, mining rare metals for return to Earth, and manufacturing goods in space from in-situ materials. Examples of common materials which might be justifiably mined from extraterrestrial surfaces include oxygen for astronauts to breath or hydrogen and oxygen for rocket fuel. The motivation for mining common materials from extraterrestrial sources would be to save the cost of launching these materials up from the surface of the Earth.

Due to the large economic value of the rare metals that can be expected to exist in near-Earth asteroids, it may be cost-effective to mine asteroids for the purpose of returning rare metals to the Earth.⁶ There may also be economic advantages to manufacturing goods in space using extraterrestrial materials. Such space-manufactured goods could include satellites used in orbit or high-value products transported to the surface of the Earth. Peter Glaser's space solar-power satellite concept is an example of a product that could be manufactured from extraterrestrial materials and used in space.

The final motivation I have identified for human activities in space is "Disaster Avoidance." I've listed asteroid deflection and weather modification as two types of space activities which might fall under the heading of disaster avoidance. Both asteroid deflection and weather modification are still in the early exploration phase.

The concept of asteroid deflection is to detect asteroids with trajectories intersecting that of the Earth and to then change the course of the asteroid enough to prevent a collision with the Earth. It would be possible to change to course an asteroid's course with any of a variety of propulsion devices now under development. Interest in asteroid deflection is motivated by the fact that significant asteroid bombardment of the Earth is known to take place on a continual basis.⁷ On an average of about once a year, an object with kinetic energy equivalent to a small nuclear weapon strikes the Earth. If such an impact were to take place near a city, the results would be catastrophic. Larger impacts, such as the 1908 Tunguska impact in Siberia, which leveled hundreds of square miles of forest, have about a ten percent chance of occurring each century. The most devastating type of impact, such as the one which might have caused the extinction of the dinosaurs, is thought to occur very infrequently, at a rate of once every few hundred million years.

Weather modification is the next example of a space activity which might be motivated by a wish to avoid disasters here on the Earth. It may be worth considering the use of many multi-kilometer sized, thin-film reflectors located in orbit to direct sunlight or cast shadows on parts of the Earth. Potential applications include nighttime illumination of cities, heating agricultural regions in times of unusual cold conditions, and shading forming

hurricanes to reduce their intensity. Little has been done with this concept, but it may merit further investigation as a space activity for the 21-Century.

The next natural step beyond weather control is climate control. Climatologists are beginning to show that human activities are affecting the climate of the Earth. One example is the production of greenhouse gases that may raise the temperature of the atmosphere. A natural question to ask is, "If we can deleteriously affect the climate by inadvertent action, why not affect the Earth's climate in a controlled fashion?" Space might be the best place from which to do controlled (as opposed to uncontrolled) climate modification. I would speculate that it may be worth considering using orbital mirrors or shades to deflect sunlight to affect changes in the total flux of solar energy reaching the Earth, and hence the Earth's climate.

THE LIKELY CONDITION OF 21st-CENTURY EARTH

We presently inhabit a globe with a population of a more than 5 billion people. Our motivations for activities in space in the 21st-century depend very significantly on the conditions of the 21st-century Earth. Figure 1 gives United Nations population projections in billions of people as a function of year for the years 1970 to 2030.⁸ This projection is based on the assumption that the population growth rate will remain near the current 1.74 percent per year until about the year 2000, and will fall thereafter to slightly less than 1 percent in the year 2025 due to a variety of demographic effects. Based on this projection, the world population will reach almost 8.5 billion by the year 2025. If the growth rate declines at a faster rate and reaches .59 percent by the year 2025, the population in 2025 will be about 7.6 billion. On the other hand, if the growth rate climbs to 1.9 percent at the end of the century before beginning a decline, the population in the year 2025 would be more than 9.4 billion people.

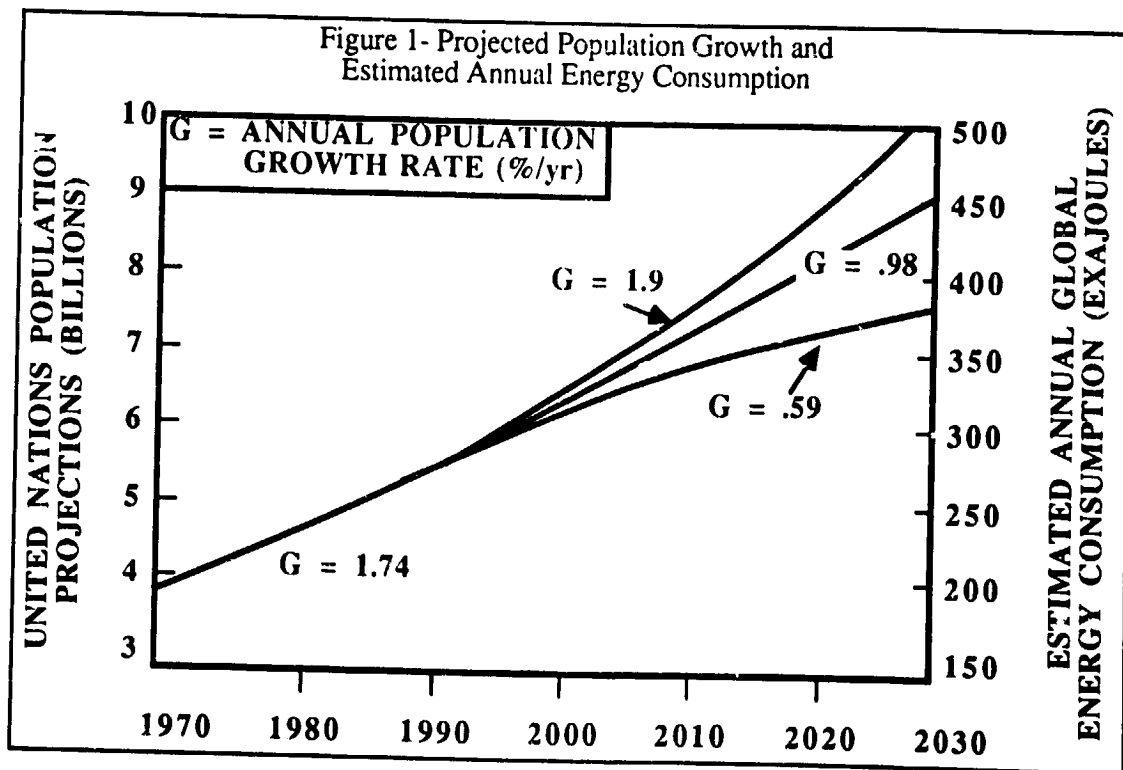

Also included in Figure 1 is a simplistic projection of global annual energy consumption based on the assumption that the globally averaged per capita energy consumption will remain constant. The units used are exojoules. One exojoule is 10^{18} joules. The consumption of one exojoule per year corresponds to a power level of about 32 gigawatts. The rate of world energy consumption in 1990 is about 300 exojoules per year, or about 10,000 gigawatts per year, most of which is consumed by the industrialized countries. According to John Givens, Peter Blair, and Holly Glen of the Congressional Office of Technology Assessment, less-developed countries consume 4 to 7 times less energy per person than do industrialized countries.⁹ As less-developed countries industrialize, it is expected that they will start to use energy at a per-capita rate comparable to the rate at which we use energy in the industrialized world. The industrialized world has a net population growth rate of only about .4 percent compared to the 1.74 percent global average growth rate. Based on these trends, globally averaged per-capita energy consumption can be expected to increase in the next thirty to fifty years. Figure 1 is therefore optimistic, and the projected increase in annual global energy consumption to about 450 exojoules by the year 2030 may be quite low.

Many of the problems facing 21st-century Earth may stem from the need to maintain a world population of 8 to 10 billion people. These problems are likely to include managing the impact of industrial processes on the terrestrial biosphere, while providing adequate energy production and material goods for the growing population. An important resource for meeting these needs can be the near-Earth asteroids.

NEAR-EARTH ASTEROID RESOURCES

The near-Earth asteroids comprise about one part in ten thousand of all the mass of the asteroid belt, or about 10^{17} kilograms of material. The near-Earth asteroids are those asteroids with average orbital radii close to one astronomical unit, or whose orbits cross the orbit of the Earth. These are of a special interest to potential space industrialists because the energy required to move material from the near-Earth asteroids to Earth orbit, or to aerobrake in the Earth's atmosphere, is relatively low, corresponding to only a few kilometers per second.

The quantity of resources represented by the near-Earth asteroids is enormous.¹⁰ For example, if all of the near-Earth asteroid material could be used to build O'Neill-type space colonies, it would be enough material to build habitats with a total living space roughly equal to that of North America. The near-Earth asteroids contain enough iron to produce the equivalent of a new car for every person in the solar system each year for a 1000 years based on an assumed total population of 10 billion people. Finally, the near-Earth asteroids contain almost a million times the raw material needed to build space solar power for satellites to meet all of the terrestrial power needs projected in Figure 1.

Another interesting observation is that if one were to separate out the precious metals in the near-Earth asteroids, one could extract a few million dollars worth of platinum group metals for each person in the solar system (at today's prices). Of course, this is just an illustrative example. It is difficult to imagine a need for such large quantity of precious metals. Just by making such a large quantity of precious metal available would render it no longer precious.

Figure 2 is a pie chart depicting some of the expected major constituents of one type of asteroid likely to be present in the near-Earth asteroids. Some important trace materials such as the platinum group metals are not shown in this figure because they represent only a small fraction of the total mass. The type of asteroid addressed in Figure 2 is a metal-rich

carbonaceous asteroid. Many other types of asteroids can be expected to be found in the near-Earth groups. As the Figure shows, aluminum, iron, carbon, water, and other useful substances are expected to be present.

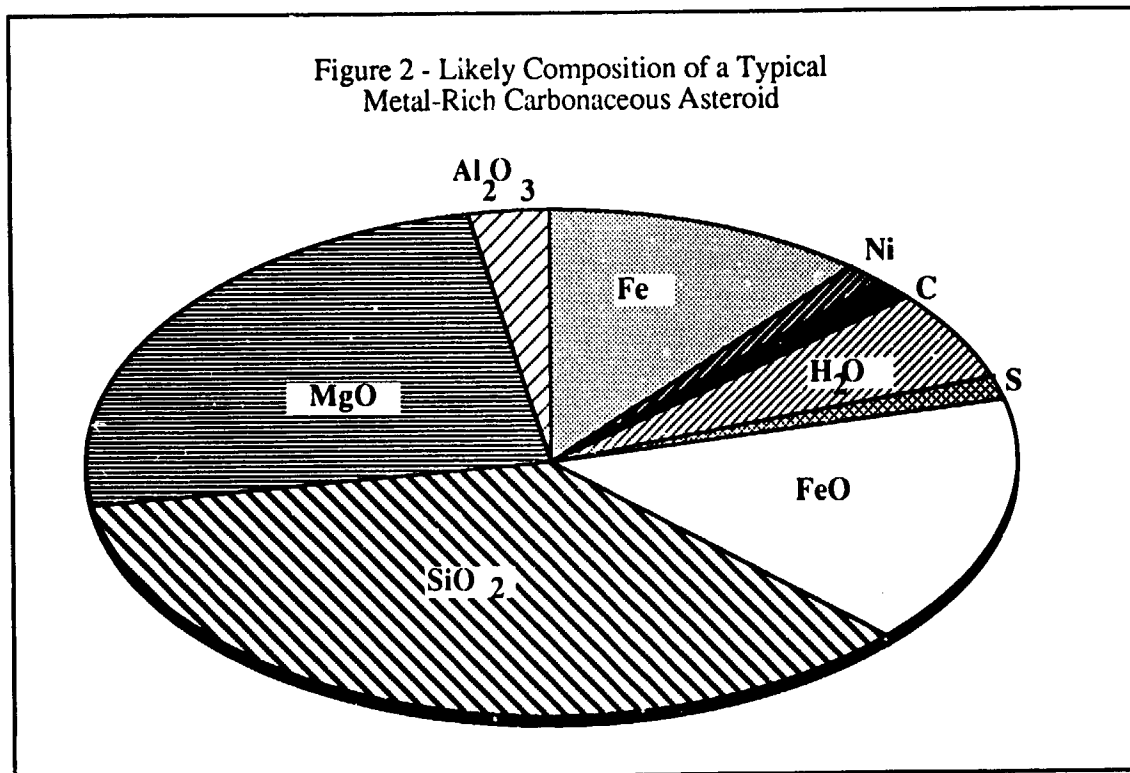

CHALLENGES OF SPACE INDUSTRIALIZATION

Based on the quantity and composition of the materials in the near-Earth asteroids, it is clear that even in a 21st-Century world of 10 billion people, the potential industrial value of the near-Earth asteroids is enough to dramatically effect the global economy and the environment. If this material is to be of use, however, challenges associated with space industrialization must be overcome. These challenges include the high cost of access to space, the hazards of the space environment, and other difficulties associated with any new enterprise, such as obtaining required capital investments, legal issues, and national policy issues.

The cost of access to orbit is typified by existing launch vehicles, which cost in the range of 1,000 to 10,000 dollars per kilogram of payload.¹¹ Technologies are being considered to reduce launch costs considerably. For example, the Advance Launch System which is now under study, may reduce launch costs to about 300 dollars per kilogram. The theoretical minimum cost for delivering payloads to space can be calculated based on the mechanical energy associated with a given orbit. Assuming 10 cents per kilowatt hour, and accelerating payloads to about 8 kilometers per second, the theoretical minimum cost for delivering payloads to low Earth orbit is a little over a dollar per kilogram. However, the technical difficulty of approaching this low theoretical cost is enormous, so for the purpose of speculating about 21st-century space industry, it is reasonable to expect that the cost of access to space will remain high.

The hazards of the space environment include isolation, radiation, vacuum, and zero gee effects. These hazards must be well understood if space industrialization is to proceed. Fortunately, in many cases, these hazards can be turned into advantages. For example, isolation from the terrestrial biosphere will allow space industrialists to use processes that are environmentally unacceptable here on the Earth. Radiation can be turned to an advantage as a power source, by (for example) using the 1.4 gigawatts per square kilometer of solar radiation for thermal power or converting some fraction of it to electrical power to drive machinery.

BASIC FUNCTIONS OF A SPACE-BASED INDUSTRY

The functions a space industry must accomplish include raw material collection, processing raw materials into useful feedstocks, parts fabrication, product assembly, and transport of products to Earth. Dramatic advancements in the technologies of power systems, sensors, and command and control systems will be needed to build an effective extraterrestrial industry. These functions and the important spacecraft subsystems associated with a large-scale space industry are depicted in Figure 3.

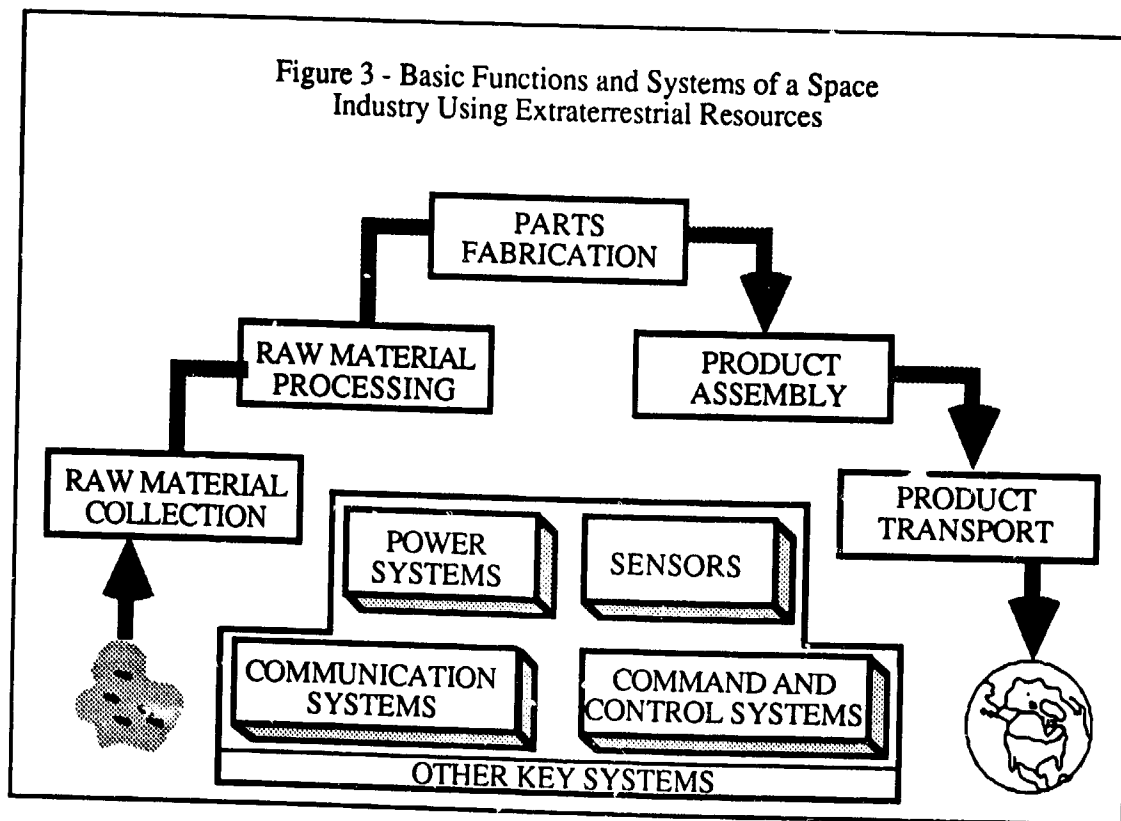

Referring to the figure, raw material collection is the process of mining or bulldozing extraterrestrial material and introducing it to the material processing plant. The chief difficulty of raw material collection is associated with the command and control of robotic systems on natural extraterrestrial surfaces. Processing raw materials involves extracting the useful component of the raw materials and converting them to forms appropriate for industrial applications. Extraterrestrial materials processing is presently receiving

considerable research attention. Once processed, the material must be fabricated into useful parts and assembled into useful products. The final products must then be transported to the Earth.

REPLICATING SYSTEMS

If the needed technological advancements are made, an important option to consider for harnessing space resources is that of replicating manufacturing systems. A replicating system can use the energy, information, and matter present in its environment to make copies of itself and some useful product. A key aspect of any proposed replicating space manufacturing system is that of closure. Three types of closure have been identified as important: energy closure, information closure, and matter closure. If perfect closure in each of these areas could be achieved, the result would be a von Neumann machine.¹² Although the prospects of producing a true von Neumann machine are not good, it is likely that within the next century replicating systems with imperfect closure can be made to effectively support space industrialization.

The first replicating factory introduced to space to initiate a space industry is called a space seed. The following discussion is based on a space seed concept developed in a 1980 NASA summer study which represents the most careful investigation to date on the subject of replicating space factories.¹³ As part of that study, it was estimated that a space seed, which could be constructed using reasonable technology and delivered to the moon or an asteroid, would have a mass of about 100 metric tons and could replicate itself in about one year.

Figure 4 is a schematic designed to communicate the basic concept of a replicating machine. Based on the assumptions given above, after one year, two factories would exist; after two years, four factories would be present; after three, eight factories would be available, and so on. At the end of 30 years approximately one billion replicating machines would be present. This assumes that the first replicating system is placed in an environment where it can replicate and has sufficient quantities of appropriate material nearby for it and its offspring to replicate. If such material is not present in acceptable forms, some small quantity of mass will have to be delivered to the machines from the Earth. These delivered materials are called "vitamins," in analogy to biological vitamins. An additional assumption is that the transportation system needed to return products to the Earth is produced by the replicating system and consumes half of the mass of the system's products, for example in the form of rockets and propellant.

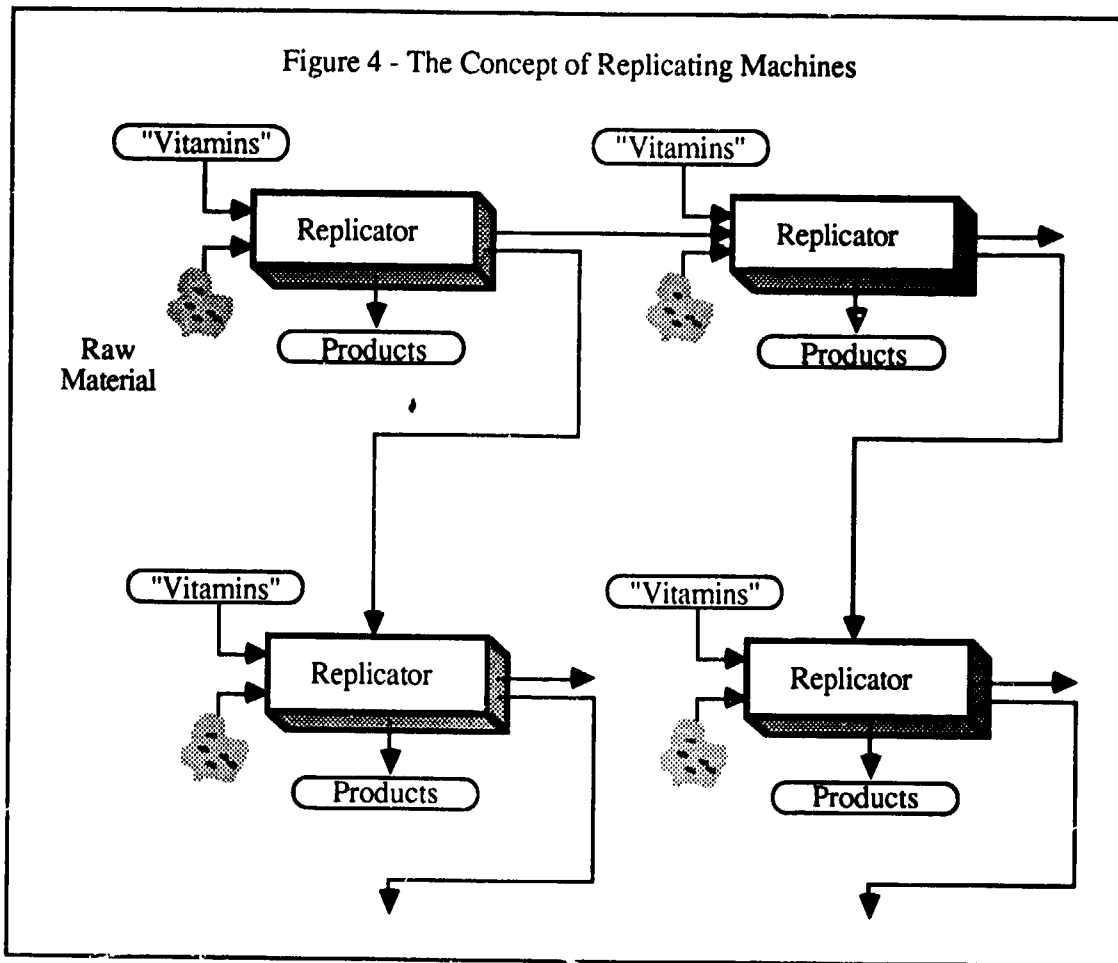
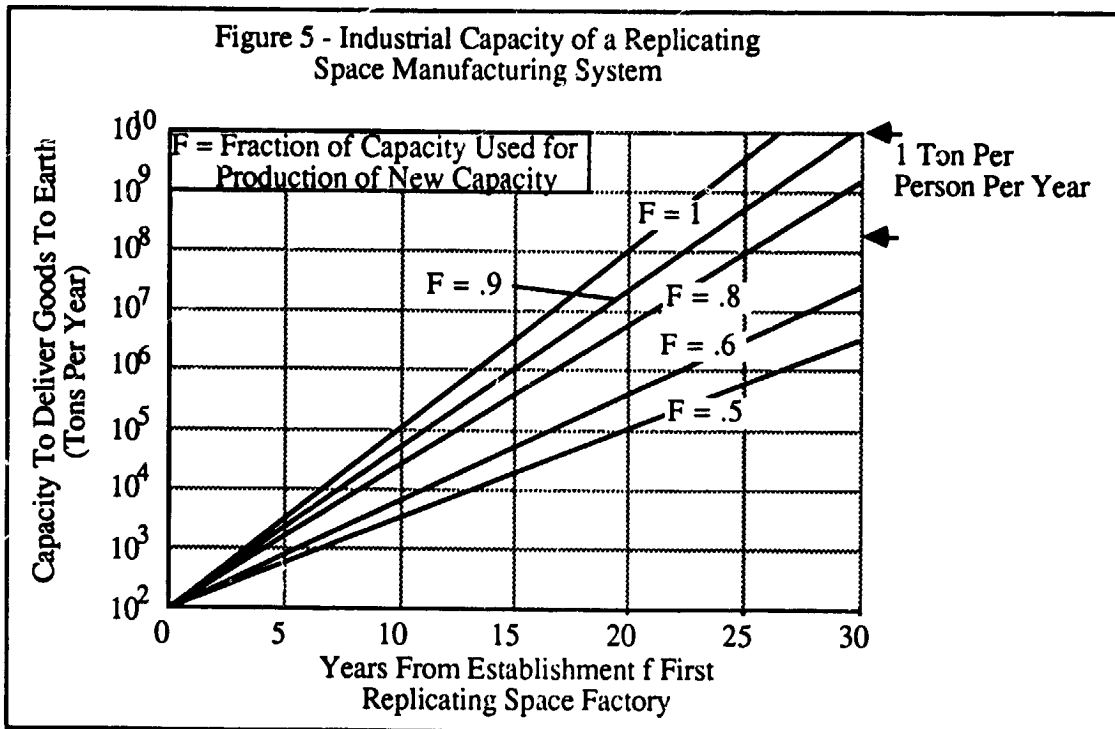

Figure 5 presents the capacity of an extraterrestrial industry based on replicating machines as a function of time after the establishment of the first replicating space factory. The vertical scale presents the capacity to deliver goods to the Earth in tons per year. The horizontal scale shows the time in years from the establishment of the first replicating factory. Five different lines are shown for different fractions of the capacity used for the production of new factories. The top line, which corresponds to the highest level of capacity to deliver goods to Earth, is based on the assumption that the entire production capacity of the replicating factories is used to produce new industrial capacity in space. The second line corresponds to the case in which 90 percent of the output of the original space factory (and its offspring) are used to produce new factories, and 10 percent of the output is used to produce useful products. The parameter F is used to describe the fraction of factory output devoted to replication. As can be seen, values of F near 1 give the highest rate of development of industrial capacity.



These same assumptions are used in Figure 6, which presents the total quantity of products delivered to the Earth as a function of time from developing the first replicating factory. Note that the $F=1$ line is not present. This is because the $F=1$ condition corresponds to no useful goods returned to the Earth, certainly not an advisable operating condition. Another interesting point to be drawn from Figure 6 is the somewhat counter-intuitive observation that the larger values of F correspond to the largest return of goods to the Earth in time periods greater than a few years. This suggests that replicating factories should be designed to focus the majority of their capacity on replication, especially in the first few years after deployment.

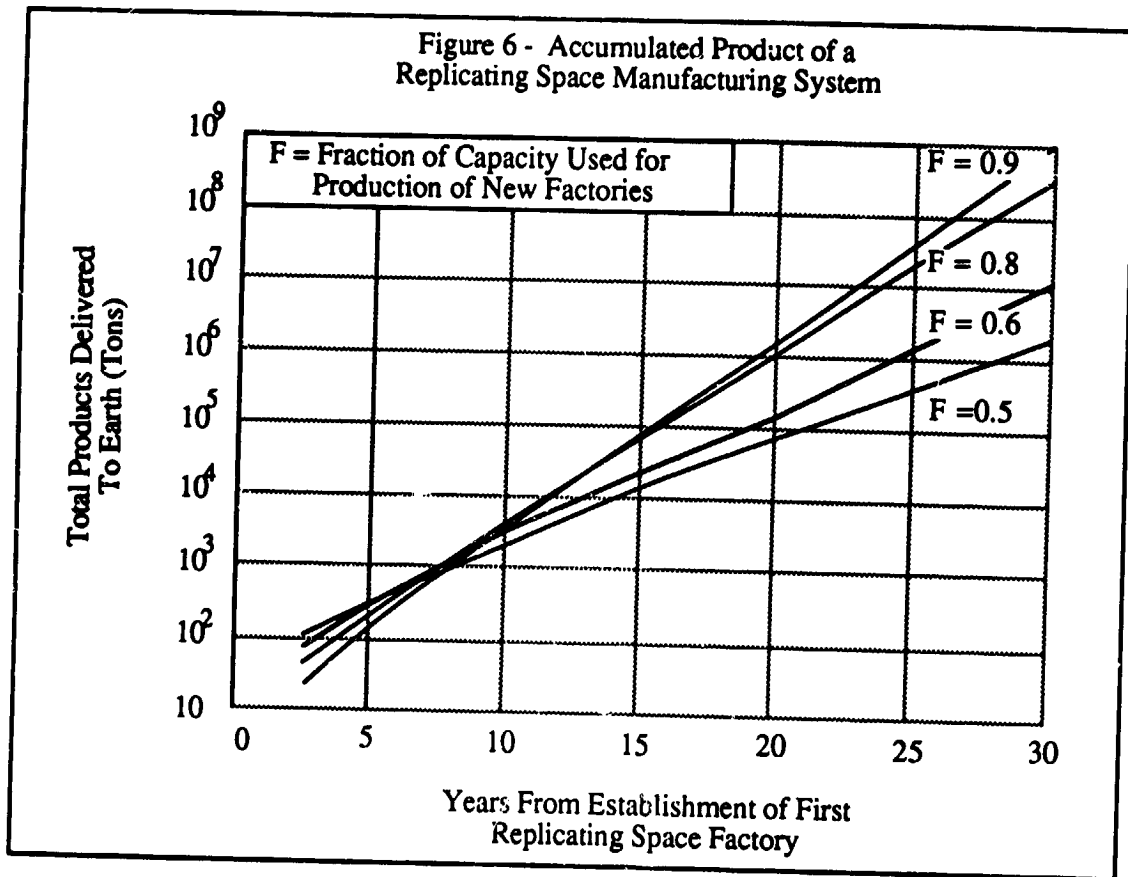
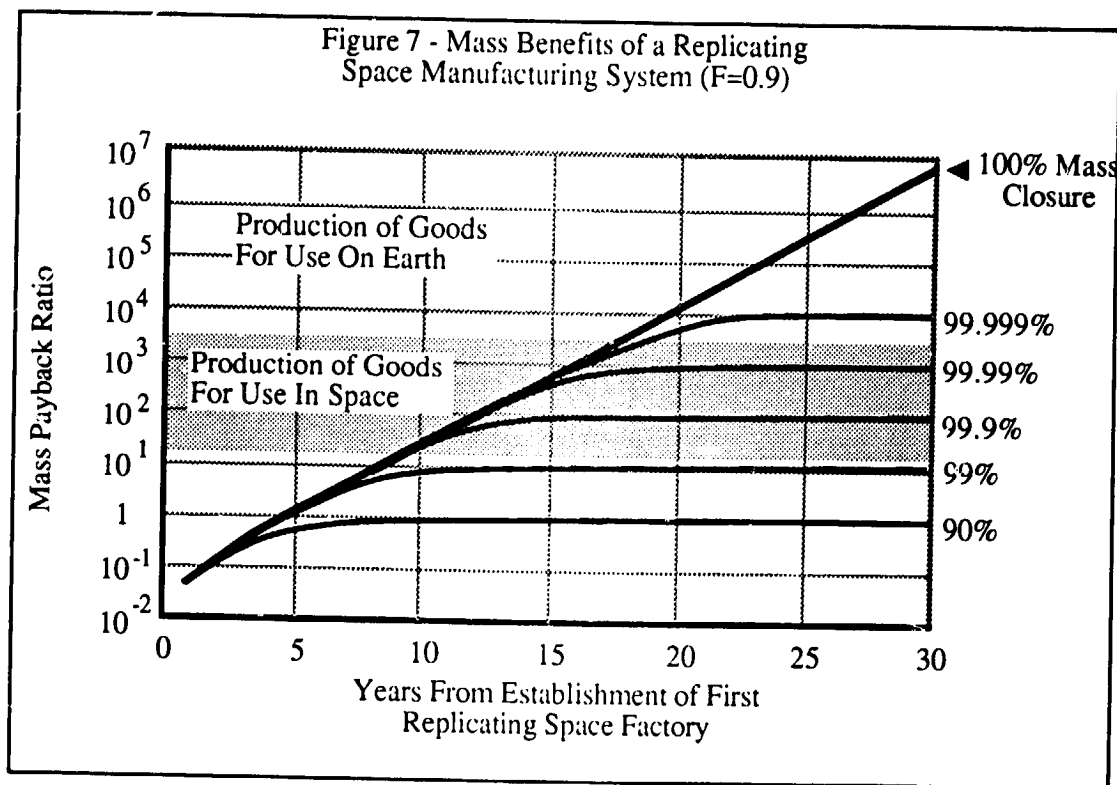

Figure 7 is an attempt to communicate exactly how important mass closure is to any potential replicating space manufacturing technology. The vertical scale shows the mass payback ratio of the replicating space manufacturing system for the case of $F=0.9$. The horizontal axis shows years from establishment of the first replicating space factory. Mass payback ratio is a term commonly used in the study of extraterrestrial resources and is defined as the ratio of the mass of useful products returned, in this case industrial goods, to the mass which had to be launched into orbit to make those goods available. Figure 7 depicts six different curves for six different mass closure efficiencies for the replicating machine. The top curve represents a 100 percent mass closure and shows what the mass payback is as a function of time for a von Neumann machine with an initial mass of 100 tons and a replicating period of one year. The other curves correspond to the labeled mass closure rates.



A mass payback of less than 1 is unacceptable. Such a condition would imply that for every kilogram of material returned from the space industry, more than 1 kilogram of material would have to be launched into space. To justify development of some level of replicating machine technology, a promise of a mass payback ratio of a least 10 or so will be needed. For example, if one were making communication satellites, a mass payback ratio of 10 would suggest that for every ton of vitamins launched into orbit, replicating machines could return 10 tons worth of communication satellites. For a highly cost-effective replicating space industry, mass payback ratios of at least 100 to 1,000 would be desirable. On the other hand, if considering the return of manufactured products to Earth for terrestrial use, then the required mass payback ratio will have to be quite large, probably well over 1,000.

Figure 7 also suggests that for replicating systems to make sense for a space manufacturing industry, virtually 100 percent mass closure is needed. If studies are done that convincingly show that high rates of mass closure are very unrealistic, then we probably shouldn't be too interested in space applications of replicating machines.

An important caveat applied to the discussion of Figures 4 through 6 is that these figures were generated based on the simplest possible strategy for replicating space systems. Specifically, the value of F was assumed constant in time. In all likelihood, this assumption will be found to be far from optimal, and the conclusions drawn here should be extended only with care.

If the development of a replicating machine technology is undertaken, there are a number of steps that the 1980 NASA summer study suggested would be appropriate. Table 2 is an adaptation of the development milestones suggested by that study.¹³

Table 2 - Development Milestones for a Replicating Space System

1. Design and construct a system which, when supplied only with parts and subassemblies, can duplicate itself.
2. Design and construct a system which can duplicate itself, and, in addition, produce some useful product.
3. Design and construct a system which, when supplied only with feedstock, can duplicate itself.
4. Design and construct a system which, when supplied with raw materials only, can duplicate itself.
5. Design and construct an automated, reprogrammable, multiproduct system which can, from raw materials, duplicate itself.
6. Design and construct an automated, reprogrammable, multiproduct system which, using only materials available on an extraterrestrial surface and using only processes possible in the space environment, can duplicate itself.
7. Design and construct an initial automatic "seed" system which, if placed on an extraterrestrial body, can deploy itself as a functional automated, reprogrammable, multiproduct system and replicate itself using only processes possible in the space environment.
8. Design and construct an initial seed which can produce useful products on an extraterrestrial body.
9. Design and construct an initial seed which can produce useful products on an extraterrestrial body and manufacture a transportation system to deliver those products to useful locations such as Earth orbit or the surface of the Earth.

A 1988 National Research Council report titled The National Challenge in Computer Science and Technology, recommended that the United States adopt the development of replicating machine technology as what they called a "grand challenge."¹⁴ The Council had several interesting observations about why such an undertaking would be advisable. Specifically, they felt that if successfully developed, the technology for replicating machines could create significant spin-offs in industry and government. They suggested that the solution to the problem of developing a replicating machine falls within many disciplines. Some of the disciplines they sighted included knowledge capture for reverse engineering, design for manufacturability, and robotics. Further, the council suggested that the development of replicating systems technology would require and would generate significant breakthroughs and fundamental advances in computer science technology. They also pointed out that success or failure would be clearly established and appreciated by nonexperts and would require long-term, stable funding at significant levels. The funding levels that they referred to were on the order of a hundred million dollars per year, but they also suggested that success in this endeavor would be guaranteed because the payoff, even if this development were to achieve far less than total success, would be substantial. Besides advancing the state of the art, the pursuit of a challenge like this would create a new generation of leading computer researchers and engineers who would, in turn, contribute to the creative and effective use of technology throughout the nation. They

called it a grand challenge not only because of the immediate accomplishment it would entail, but because achieving replicating machine technology would give rise to immense technological spin-offs benefiting industry, defense, and society.

CONCLUSIONS

- The near-Earth asteroids contain tremendous material resources which, if harnessed, could have a beneficial effect on the world economy and the environment of planet Earth.
- Autonomous manufacturing technologies techniques may be needed to harvest the wealth of the asteroids.
- Given the magnitude of the potential benefit of a full-scale space industry, development of advanced automation technology and extraterrestrial-materials-processing systems should be vigorously pursued.
- Developing replicating manufacturing technology could be a grand challenge on which to focus American energies in the 21st-century.

REFERENCES

1. Robert A. Heinlein, Time Enough for Love, New York, New York: Berkley Medallion Books, 1974.
3. Gerard K. O'Neill, The High Frontier: Human Colonies in Space, New York: Morrow, 1976.
2. Peter E. Glaser, Feasibility Study of Solar Power Stations, NASA CR 2357, 1974.
4. Boeing Aerospace Company Contractor report submitted to The NASA George C. Marshall Space Flight Center, Analysis of Space Systems Study for the Space Disposal of Nuclear Waste, 1981, NASA Contract NAS8-33847.
5. See the September 1986 Issue of Fusion Technology
6. Brian O'Leary, Space Industrialization - Volume 1, CRC Press, Inc., Boca Raton, Florida, 1982.
7. Garrit L. Verschuur, Cosmic Catastrophes, Adison Wesley Publishing Co., Mass. (1978).
8. Nathan Keyfitz, "The Growing Human Population", Scientific American, Vol. 261, No. 3, September 1989.
9. John H. Gibbons, "Strategies for Energy Use", Scientific American, Vol. 261, No. 3, September 1989.
10. John Lewis, Nonterrestrial Resources - Summary, from the Proceedings of the Ninth Princeton/AIAA/SSI Conference, May 10-13, 1989.
11. Ronald W. Klemetson, Expendable Launch Vehicles Summary for JPL Mission Planning, Jet Propulsion Laboratory Internal Document, JPL D-6936, March 1990.
12. John von Neumann: The General and Logical Theory of Automata, In Cerebral Mechanisms in Behavior - The Hixon Symposium, L. A. Jeffress, ed., John Wiley & Sons, N.Y., 1951, pp 1-31. Also in Collected Works, vol. 5, pp 288-328
13. Robert A. Freitas and William P. Gilbreath eds., Advanced Automation for Space Missions, NASA Conference Publication 2255, Proceedings of the 1980 NASA/ASEE Summer Study sponsored by the National Aeronautics and Space Administration and the American Society for Engineering Education held at the University of Santa Clara, Santa Clara, California, June 23-August 29, 1980.
14. The National Challenge in Computer Science and Technology, National Research Council, Computer Science and Technology Board, Commission on Physical Sciences, Mathematics, and Resources: National Research Council: NATIONAL ACADEMY PRESS, Washington, D.C. 1988.

Speculations About Goals and Challenges

in a Millenium of Space Ventures

Paul B. MacCready

AeroVironment Inc, Monrovia, CA

Summary

One characteristic that seems to be shared by the major exciting ventures in space is need for the commitment of huge resources over decades. Increasingly competing for such commitment will be initiatives focused on the earth, as rapidly growing human pressures are found inconsistent with preserving our agricultural base and the ecosystem on this non-expanding globe. Therefore the best, and perhaps only, chance for significant pioneering in space will arise from first helping establish a sustainable situation on earth.

Introduction

The following speculations come from the only person at this conference who has had practically no professional involvement with space ventures. From this vantage point of non-involvement, I am able to look at the opportunities from a personal perspective, and, without an investment in being right, present views that may well be wrong. If the views stimulate discussion, they will have served their purpose.

The views evolved from an unusual decade of experiences with vehicles that operated on land, sea, or air, with extremely low power -- the power of human muscle, photovoltaic cells, or small batteries. All of these slow, fragile devices are "impractical." by any ordinary definition of the word, but they may nevertheless have considerable value:

- By focusing attention on doing more with less, they broaden perspectives and help raise expectations and standards about conserving material and energy -- a topic of fundamental importance as civilization moves into the era of limits.

- Those that meld biology with engineering prompt us to think about balancing nature and technology so that technology remains a servant rather than becoming our master.
- As examples of innovation they stimulate us to think about how to remove mental blinders in order to foster creativity, perceive the real world more honestly, and contemplate the future with more vision.

Thus these vehicle projects have been the stimulus for getting into very serious subjects, such as the meaning of life and the future of civilization. The exercise of looking at the major issues focuses one's attention on goals. A dominant goal many people share is "mankind reaching a comfortable accommodation with the flora, fauna, and resources of this limited earth". This is not a universally accepted goal. The pragmatists realize it is unachievable and therefore unrealistic. Some people dedicated to space ventures consider a more appropriate destiny for earth is to launch "intelligence" into the vastness of the cosmos; the fate of life on earth is deemed less significant. The ultimate goal is not definable by science or technology. The choice derives from philosophy or religion, or from circumstance that decides for us.

The Present and Future Situation on Earth

Few people really comprehend the magnitude of the transient in which civilization now finds itself. The individual sees that the present is rather similar to last week, and to last year, and so does not perceive the bigger picture automatically.

We are all products of the recent industrial and technological revolutions. We forget that just 200 years ago the human population was small and virtually all humans got by on their own power, supplemented just a bit by the muscle of domesticated animals and some occasional wind and water power. In 1959, British industrialist Henry Kremer established a sizable prize for human powered flight -- a remarkable challenge that connects modern technology to our biological roots and so gets us thinking about the changes over the last two centuries. Our Gossamer Condor won Kremer's prize in 1977, and this got me onto the lecture circuit, having to sort out thoughts about the project's meaning and where it leads. This was the catalyst for an emphasis on the subjects of change and the future.

To put population growth in perspective, I note that in 1925 when I was born there were 1.7 billion people. It had taken life on earth over 3.5 billion years to reach this human

population level. Now, in my brief lifetime, the population has tripled to 5.1 billion. At the same 1.8% increase per year, there will be another 1.7 billion in just 16 years, when your nursery school toddler is starting college. In 50 years at this rate the population calculates out to over 12 billion; in 100 years over 30 billion. In 1700 years, at this exponential growth rate the mass of people will exceed the mass of the earth; it will be people all the way down. Obviously a limit will be reached sometime earlier, but I doubt that the maximum will be down in the 8-10 billion range as many people argue. They ignore the increased longevity that modern science is likely to provide, the increased food production that new technology can help generate, and the pressure for population growth in the culture of some lands and religions.

Omitted in this discussion of human population increase is the impact on the global flora and fauna, the other 30 million species now so threatened by one very recently arrived species, homo sapien. The latest estimate is that we are now causing extinction of species at one every four minutes! Mankind's conquest of nature is increasingly effective. The tragedy is that we are winning.

The relative importance of mankind vs the rest of nature's species is for us to decide. Unfortunately the evaluation is made by humans, who are not unbiased and instinctively assume a human importance. Exploring such questions is helped by getting our minds opened by science fiction literature and by scientific cosmological investigations. To start from a broad perspective, we can imagine discussing the subject with some galactic explorer that visits earth every 100,000 years or so.

However, we humans will decide these issues, by careful thought or by default. Nature will probably get short shift, except to the extent that we perceive a direct, short term benefit to us from respecting it. We are starting to think about the inconveniences to us as top soil erodes or trees for fuel disappear, or as the demise of rain forests disturbs us globally via the green house effect. Let's say technology can somehow overcome these troubles. There is still the deep question of whether a person is really human when divorced from the ecological base in which our evolution took place -- similar to the question of whether an animal species still exists when all its members are confined to zoos, and not connected to its natural habitat. Humans are so adaptable they can live in large numbers in a confined, prison - like atmosphere. Without a change from our growth - oriented culture, this may be the prevailing situation in not too many decades. Obviously the subject of goals for civilization deserves an emphasis it is not presently receiving. The

crystal ball is cloudy beyond even a few decades; a millenium is beyond realistic comprehension.

Conclusions

The exploration of space opens up thinking about big issues related to the meaning and goal of human life, and the destiny of civilization. When one looks at the growing pressures an expanding population with expanding per-capita expectations puts on a non-expanding earth with a shrinking ecological and resource base, one concludes that society will soon be paying more attention than at present to trying to achieve an acceptable situation on space ship earth. The subsequent allocation of resources of dollars, brains, and interest will likely preclude the mounting of any giant space initiatives, even if the initiatives can be made international. If a long term comfortable accommodation with earthly limits is achieved (and there are only a few decades before a favorable outcome is precluded), the space missions can then become reality. If the accommodation is not achieved, big space ventures will not be carried to completion. It therefore behooves the space groups to delay the push for big programs and devote more resources to the uses of space to help global survival: environmental monitoring, communications, solar terrestrial relationships, exploration of our (and the earth's) past, and our role in the cosmos.